



Pressure Fit System -
Two Post Version



Owner's Manual

Use and Care

Trouble Shooting

Warranty Information

Table of Contents

Pressure Fit System

Introduction.....	3
Overview of the Pressure Fit System	3
Placement of the Pressure Fit System.....	4
Components of Pressure Fit System.....	5
Component list	6
Specifications of the Pressure Fit System.....	6
Requirements and Cautions.....	7
Assembly	
Assembling the Support Posts.....	10
Mounting the Adjustable Track	15
Final Inspection Prior to Use.....	16
Completed Pressure Fit System	17
Mounting the Portable Lift	18
Disassembly	
Track Disassembly Instructions.....	19
Support Post Disassembly Instructions.....	20
Trouble Shooting	22
General inspection and maintenance.....	24
Service record history	26
Warranty.....	30



CAUTION: DO NOT ATTEMPT TO USE THIS EQUIPMENT WITHOUT FIRST UNDERSTANDING THE CONTENTS OF THIS MANUAL.

Introduction

Before using this equipment, and to ensure the safe operation of your Pressure Fit System, carefully read this entire manual, especially the section on “**Requirements & Cautions**”. The Pressure Fit System is designed to be used in conjunction with Xcpectg.[®] portable lift units, accessories and slings. Please refer to any user guides supplied with these components and reference them while reviewing this manual.

Should any questions arise from reviewing this manual contact your local authorised Waverley Glen dealer. Failure to comply with warnings in this manual may result in injury to the operator, or the individual being lifted/transferred. Damage to the lift and/or related components may occur. Be sure that the contents of this manual are completely understood prior to using this piece of equipment.

Store this manual with the documents included with the lift system and sling (s). Contents of this manual are subject to change without prior written notice.

Overview of the Pressure Fit System

The Pressure Fit System is a lifting aid used by health care professionals and those providing care in the home to lift, position and transfer clients or a disabled family member. The Pressure Fit System is part of what is termed overhead lift technology which takes advantage of lifting from above and not from below or the side. The Pressure Fit System makes it possible to move mobility impaired individuals with minimal strain or risk to the caregiver, while providing complete safety, dignity and comfort for the client or family member.

The Pressure Fit System is designed to work with a Xcpectg portable lift system such as the P-440. Use of other portable lift units with this system may be possible. However, please contact your local authorised Xcpectg.[®] dealers in order to obtain approval before use.

The Pressure Fit System can be used to lift and transfer individuals from a bed, chair or similar fixture. The length is adjustable and thus can be assembled to suit a wide range of applications. The Pressure Fit System is easy to assemble and can be completed by just one person in a short period of time. Additionally, no tools are required. It is also light in weight and once dismantled, can be moved to another location such as a hotel or cottage.

Please review the following pages that outline the parts included with your package. Should you have any questions about this product or its use contact your local authorized dealer.

Placement of the Pressure Fit System in a Room

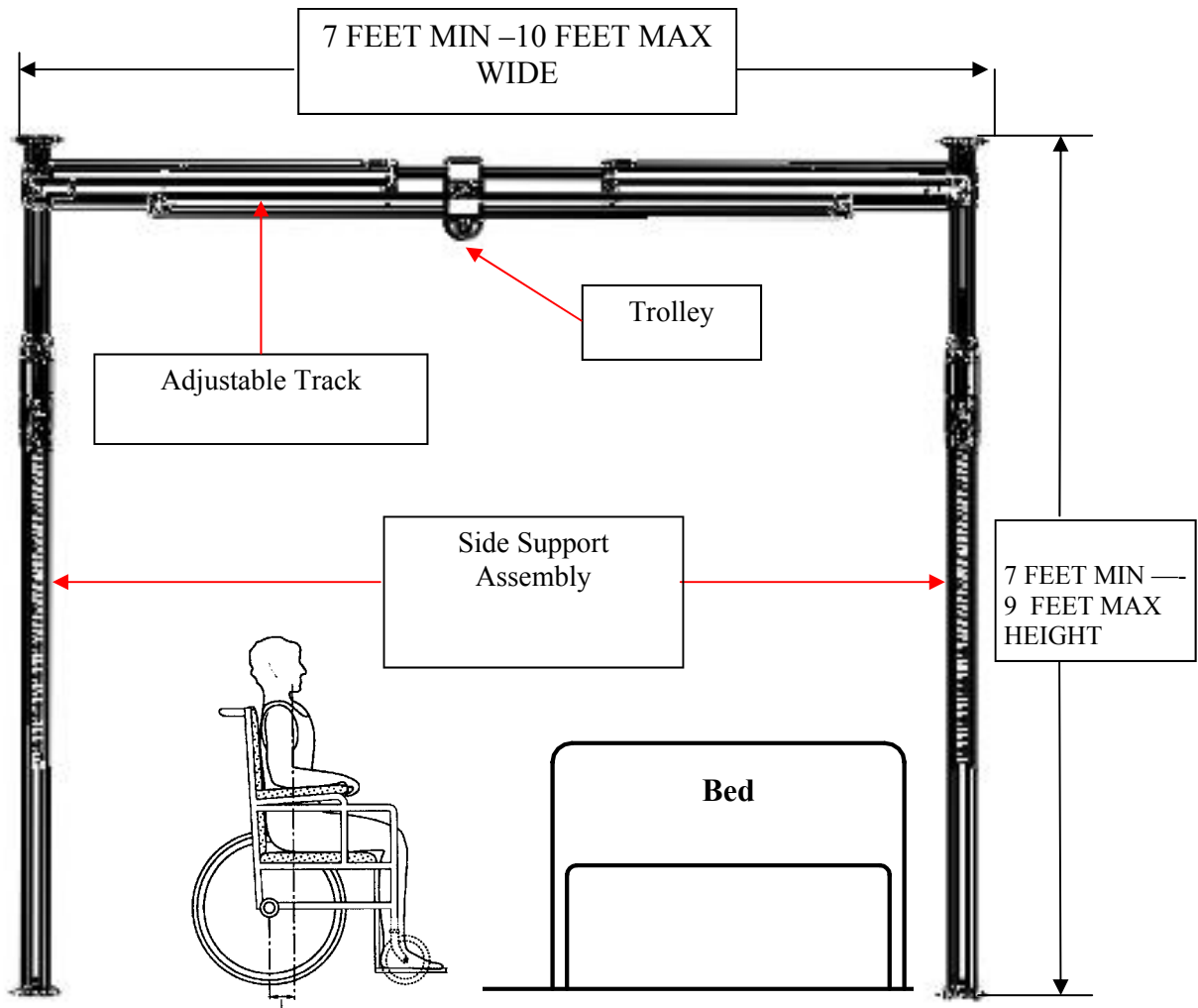

Transferring Patient from Chair to Bed

Drawing showing Front View of the pressure fit system set up in a room. In this drawing arrangement, a general placement of a bed is shown in relationship to the Pressure Fit System. Notice that there is still room for a wheelchair to be placed beside the bed. The front view show min and max height and width of the pressure fit system for which it can be set up.

DO NOT GO OUTSIDE OF THIS RANGE OF PLACEMENT OTHERWISE INJURY MAY OCCUR TO THE OPERATOR OF THE LIFT AND/OR THE INDIVIDUAL BEING TRANSFERRED, AND/OR THE PRESSURE FIT SYSTEM.

Components of the Pressure Fit System



Figure 1A- FULLY ASSEMBLED PRESSURE FIT SYSTEM

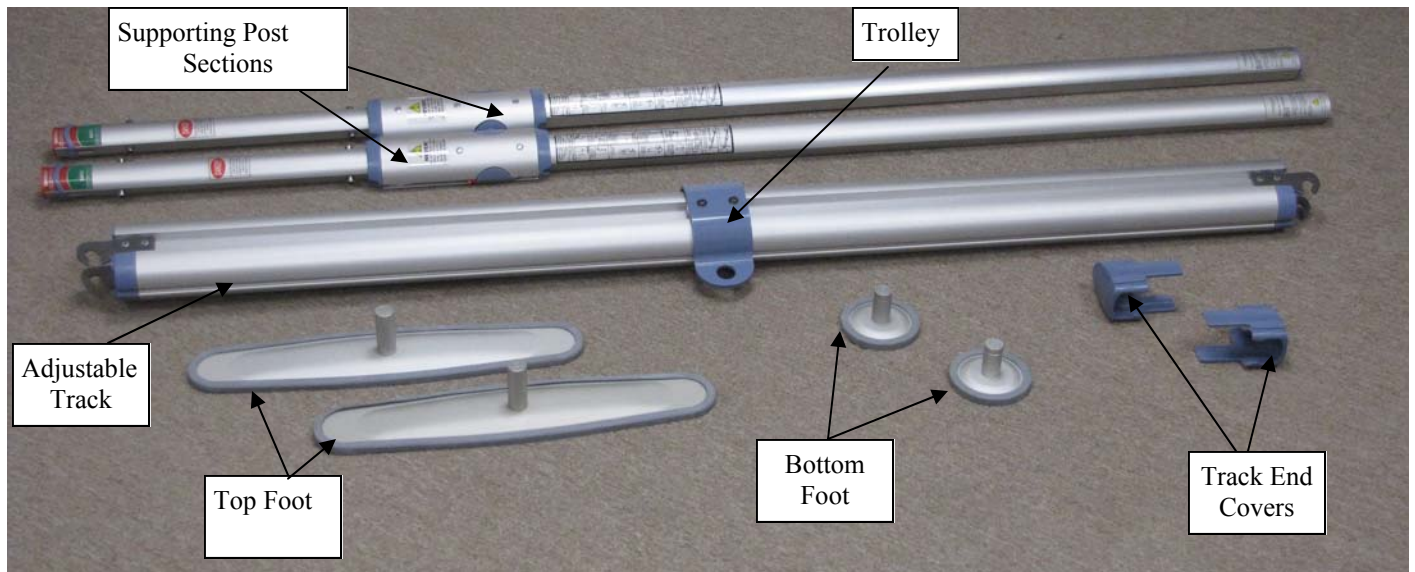

Figure 1B - DISASSEMBLED PRESSURE FIT SYSTEM

Component List

The following components are included with your new Pressure Fit System:

Description	Quantity
Bottom Foot	2
Top Foot	2
Supporting Post	2
Adjustable Track	1
Owners Manual	1
Warranty Card	1

Specifications of the Pressure Fit System

- High-strength lightweight Aluminum
- Portable or semi-permanent installation
- Eliminates the mounting of a connection system in the ceiling
- Pressure gauge indicator to help ensure proper installation
- Quick attachment with secure fixings
- Addresses a number of different bedroom & bathroom situations
- Weight capacity 440 lbs
- Adjustable in length
- Built-in easy-slide trolley
- Exerting pressure between Floor and Ceiling is 80 to 100 lbs.
- Specially designed and engineered rubber molded feet for ultimate grip
- Leveling indicators on posts
- One (1) year warranty

Minimum - Maximum Dimensions

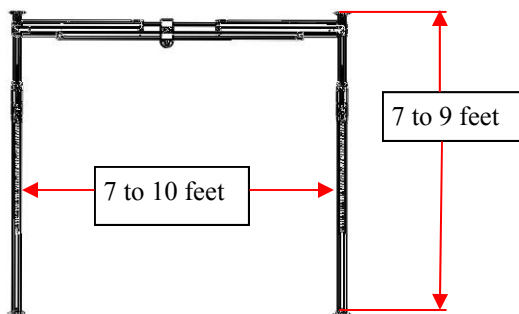

Model Table for the Pressure System

Code	Description
341500	Pressure Fit System - Two Post Version.



Before you start: Check Requirements and Cautions

Requirements:



Failure to meet the requirements listed below could result in serious injury or death.

CEILING REQUIREMENTS:

- Install the Pressure fit system to a rigid ceiling structure.
- Ceiling structure must have joists that are spanned maximum up to 24” between the trusses.
- Ceiling made of wood must be at least 12.7mm / 1/2” thickness.
- Ensure the ceiling structure is not suspended by wires or rods.
- Ensure ceiling should be clear of any cracks, grease, water or any other slippery substance.

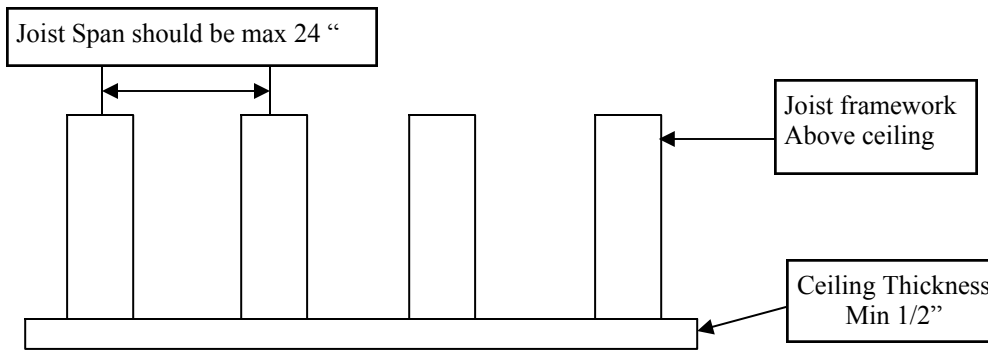

FLOOR REQUIREMENTS:

- Ensure Floor area is cleaned and free of dirt & debris.
- Floor should meet the requirements of building code standards.
- Floor must not have a slope of more than .5 degree. See table below to determine the slope of floor.

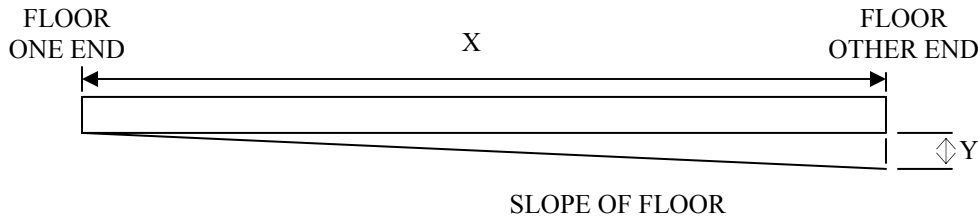

X (DISTANCE BETWEEN FLOOR ENDS)	6 FEET	7 FEET	8 FEET	9 FEET	10 FEET
Y (MAXIMUM SLOPE OF FLOOR AT SPECIFIED DISTANCE)	.630"	.733"	.837"	.942"	1.047"



Before you start: Check Requirements and Cautions-continued

Cautions:



Failure to observe cautions listed below could result in serious injury or death.

Cautions: Before installation

- The pressure fit system parts should not be loose, broken or bend. If any part is missing or damaged do not install. Contact your local authorized dealer immediately.
- The Pressure Fit System must be assembled prior to use. Should you have any questions during assembly contact your local authorised dealer.
- Never installed the Bottom foot plate on the top portion of post section or vice versa. See section “Assembly” instructions.
- Ensure rubber feet are cleaned and dry prior to each use. See section “ General Inspection and maintenance”.
- Do not install The pressure Fit System to suspended ceiling.
- Do not install The pressure Fit System on a plaster ceiling.
- Do not install on a sloped floor greater than .5 degree.
- Ensure floor area is clear off dirt and debris.
- Never expose the Pressure Fit directly to water. Warranty does not cover any misuse or abuse of the Pressure Fit system.
- Any accessories used with the Pressure Fit System including lift and sling (s), should be checked to ensure that they are in good working order. Check for signs of wear or fraying prior to use. Report any unusual wear or damage immediately to your local authorised dealer.
- Ensure that a clear space is maintained around the Pressure Fit System. Remove all furniture and other obstacles out of the way before performing a transfer.



Before you start: Check Requirements and Cautions-continued

Cautions: After Installation

- Ensure that the pressure gauge is in the safe zone during set up.
- Ensure Posts are level both visually and with the built in level. If unsure, use a master level to verify the straightness of the Posts.
- Make sure track is sitting properly on the posts.
- Make sure trolley is sliding smoothly on the track.
- Make sure safety lock button and level are locked.
- Never unlock the Post when Track is attached.
- Do not under any circumstance exceed the maximum load rating for this piece of equipment. Refer to the “Specifications” section of this manual.
- The installation of the Pressure Fit System, lift, accessories, and sling are certified to a maximum load. Do not exceed the maximum rated load of any of the components.
- The Pressure Fit System has been designed to lift vertically at its maximum load and at its maximum height. Do not attempt to lift an individual at an angle to the track.
- The Pressure Fit System and associated lift, and sling(s) are intended **only** for lifting and transferring of a person. Xcpectg will not be responsible for any damage caused by the misuse, neglect or purposeful destruction of the lift and/or its’ associated components.
- Under no circumstance should the track, lift and sling (s) or entire system be put in control of a person who has not been properly trained in the use and care of this equipment. Failure to adhere to this warning may result in serious injury to the operator, and/or the individual being lifted/transferred.
- In places where more than one operator will be responsible for using the Pressure Fit, associated lift and sling(s), it is imperative that all operators be trained in its’ proper use.
- The Pressure Fit System and associated lift and sling (s) are not toys. Do not use them for unsafe practices. Do not allow children to play with the this equipment or any of its components.
- To maintain optimum function, the Pressure Fit should be inspected and maintained on a regular basis. See the section titled “General Inspection and Maintenance”.
- The manufacturer's warranty is void if persons unauthorized by Xcpectg perform work on the Pressure Fit System.

Assembly

⚠ Caution: Before using the Pressure Fit System, the top plate, bottom plate, supporting posts and adjustable track must be visually checked to ensure that there are no missing parts or unusual wear and tear. Top plate and Bottom plate should be cleaned and dry with wet cloth before installation (See Cleaning Rubber Feet Instructions). Should anything look unusual contact your local dealer prior to use.

Failure to comply with this caution could result in serious injury to the operator, the individual being lifted and/or damage to the Pressure Fit and/or portable lift unit.

Assembling the Support Posts



Step 1:
Placed the bottom foot on the floor. Insert the bottom plate through the opening located at the bottom of the supporting post.

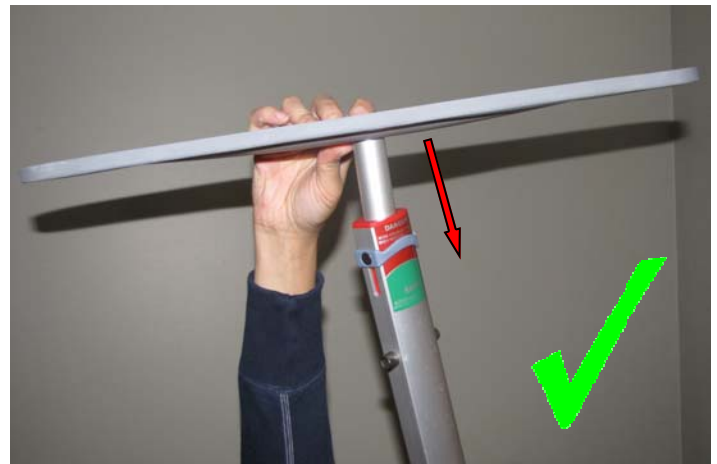

Step 2:
Tilt the supporting post to the side to facilitate the installation of the top foot. Insert the top plate through the top opening of the supporting post.



NOTE:
Never install Top Foot at the Bottom section of Post



NOTE:
Never install Bottom Foot at the Top section of Post

Assembly

Assembling the Support Posts (Continued)



Step 3a:
Press the red button down to release the safety lock.



Step 3b:
Safety Lock Released.



Step 4a:
Grab and Push down on the top section of post with two hands as shown in Picture.

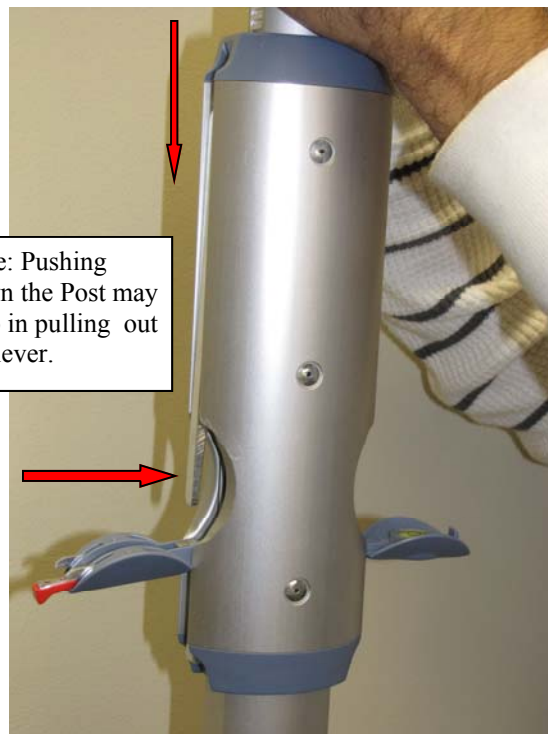

Note: Pushing down the Post may help in pulling out the lever.

Step 4b:
While pushing with two hands, the lever will move out as shown in picture.
Note:
This will help in pulling out the lever.

Assembly

Assembling the Support Posts (Continued)



Step 5a:
Press in and hold the Ratchet while pulling out the lever .



Step 5b:
Push the lever up to engage with the magnet.



Step 6:
Push the top section of post up towards the ceiling with Top foot. Upon contact with the ceiling, continue pushing up until you hear one or two more “clicks”.

Note:
At this point, the post should be exerting pressure between the floor and ceiling.



Step 7:
Swing open post level. Please ensure the level is fully open.

Assembly

Assembling the Support Posts (Continued)



Step 8a:
Grasp bottom section of post, lift slightly and adjust until bubble is centered and post is perpendicular to floor and ceiling.



Step 8b:
Bubble centered.



Step 9a:
Pull the lever down until it “clicks” into place.

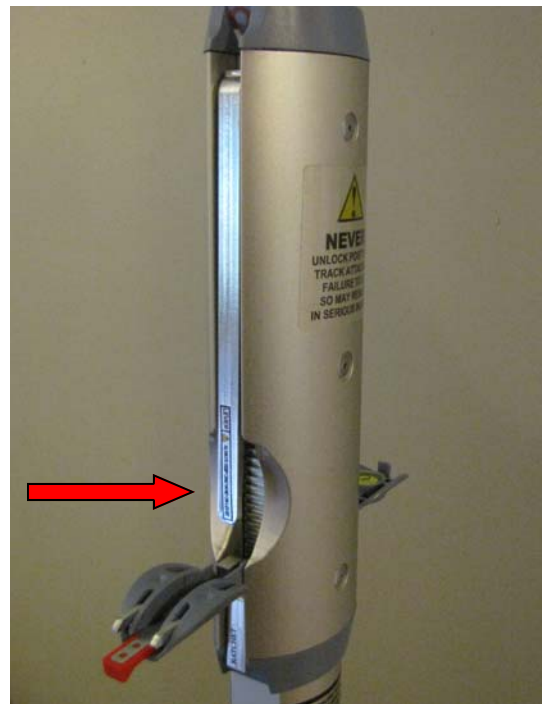

Step 9b:
Press the lever in to secure it.
Note: Lever must rest in vertical position.

Assembly

Assembling the Support Posts (Continued)



Step 10:
Ensure Pressure Gauge is in the Safe Zone.
Note: Green must be visible on both sides.



Step 11a:
Swing back the safety lock and level to the original position.



Step 11b:
Safety Lock and Level must be firmly Engaged in housing.

Step 12:
Install the second post repeating steps 1 through 11.
Note:
The distance between the two posts should be 7 to 10 feet.

Mounting the Adjustable Track

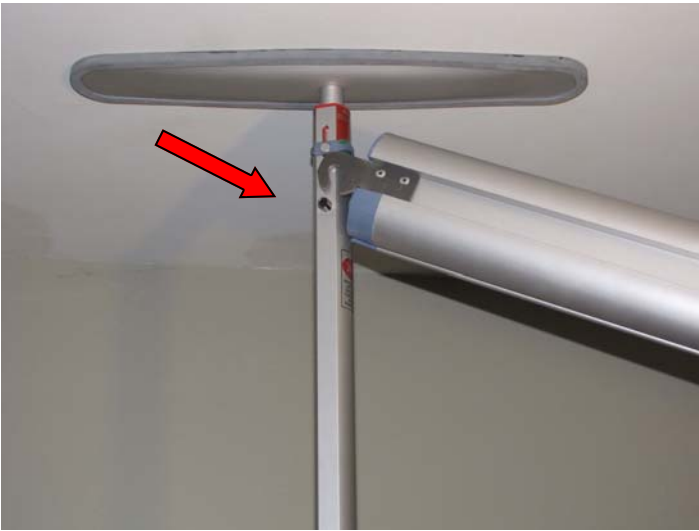

Step 13a:
Hook one end of the track to post pin.



Step 13b:
Extend the track and hook to the other post.



Note: Ensure track connector is sitting properly on the spring pin as shown above.

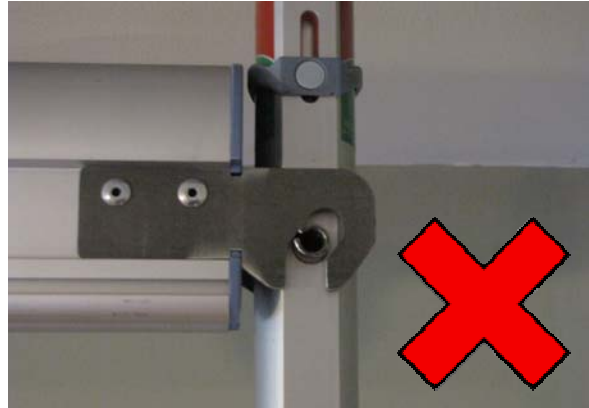

Note: Don't leave the track connector on the spring pin as shown above.



Step 14a:
Attach the track end cap as shown above.



Step 14b:
Install the other end cap.

Final Inspection Prior to Use



Ensure Pressure Gauge is in the Safe Zone.

Note: Green must be visible on both sides.



Safety Lock and Level must be firmly Engaged in housing.



End covers are installed properly

Completed Pressure Fit System



Completed Pressure Fit System with a M-400 lift.

Mounting the Portable Lift

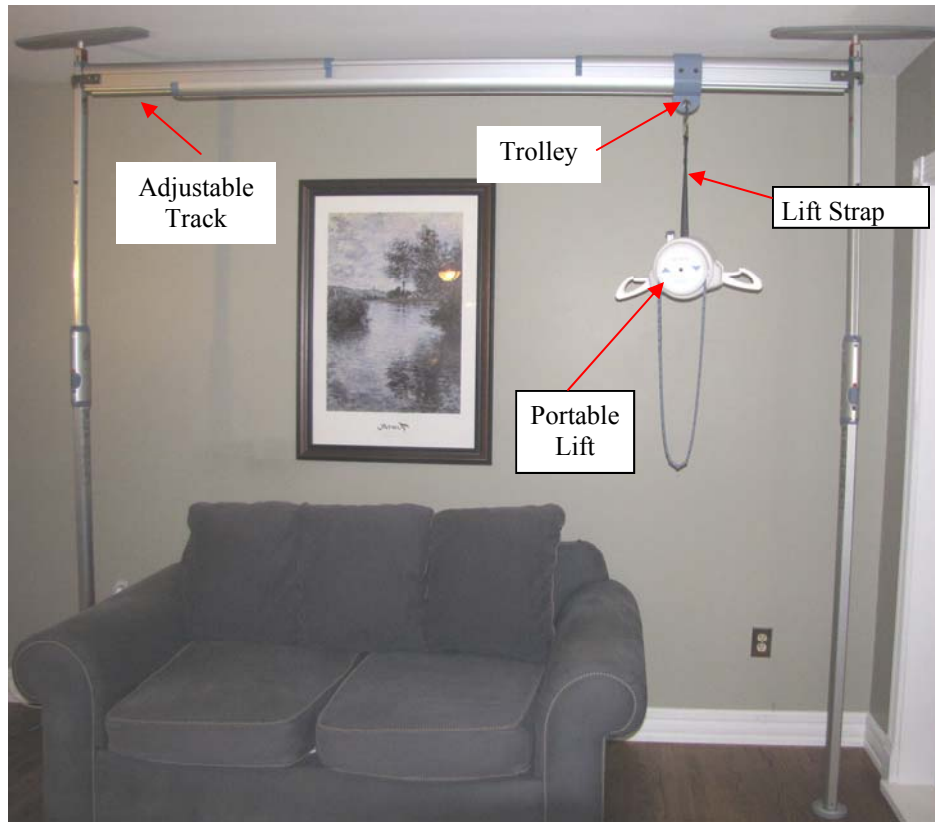

Figure 1A– FULLY ASSEMBLED PRESSURE FIT SYSTEM

Prior to mounting the portable lift onto the trolley of the Pressure Fit System, please read the owners manual of the portable lift. Be sure that the instructions on the use of the lift and any accessories, such as slings are thoroughly understood before attempting to use them with the Pressure Fit System.

FAILURE TO COMPLY WITH THIS MAY RESULT IN INJURY TO THE INDIVIDUAL BEING LIFTED AND/OR THE CAREGIVER, OR DAMAGE TO THE LIFT AND/OR THE PRESSURE FIT SYSTEM.

Following the instructions for the portable lift, attach the carabiner, (or other similar attaching device) located at the end of the lift strap, to the hole of the Pressure Fit trolley. Be sure that the carabiner is securely attached to the trolley prior to proceeding with the transfer.

FAILURE TO COMPLY WITH THIS MAY RESULT IN INJURY TO THE INDIVIDUAL BEING LIFTED AND/OR THE CAREGIVER, OR DAMAGE TO THE LIFT AND/OR THE PRESSURE FIT SYSTEM.

Proceed to transfer the individual in the manner described in the owners' manual for the portable lift and sling. When the transfer is completed the lift may be removed from the trolley.

Track Disassembly Instructions

⚠ Warning: Failure to read and follow these instructions carefully may result in serious Injury.



Step 1:
Remove the end caps from both posts.



Step 2a:
To Unhook the track assembly, lift the track up from one post end.



Step 2b:
Squeeze the track and unhook from the other post end



Step 2c:
Store the removed adjustable track in a safe place.

Supporting Post Disassembly Instructions

⚠ Warning: Failure to read and follow these instructions carefully may result in serious Injury.



Step 3:
Press the red button to release the safety lock.



Step 4:
Press the lever in all the way to release the pressure from the ratchet.



NOTE: Lever May Swing Out. Always keep one hand on the lever

Step 5:
While pressing in the lever, push and hold the ratchet.

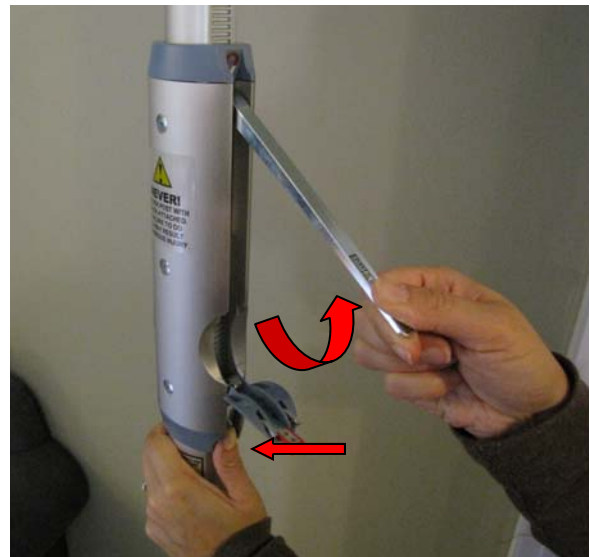

Step 6:
While holding the ratchet, pull out the lever.

Supporting Post Disassembly Instructions



Step 7a:
Push the lever up to engage with magnet.

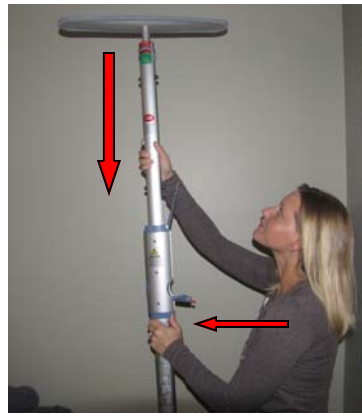

Step 7b:
Push in and hold the ratchet while pushing the top section of post down.



Step 7c:
Make sure the bottom pin touches the plastic cover.



Step 7d:
Bring back the lever to vertical position.



Step 8:
Bring back the level and safety lock to original position.



Step 9:
Take off top and bottom Foot.
Store the components in a safe place.

Repeat steps 3 to 9 for the other Post disassembly .

Trouble Shooting

Should problems arise with the use of the Pressure Fit System review the following chart. Find the fault and complete the recommended solution. If the fault is not found and/or the solution does not correct the problem contact your local authorized dealer for service immediately.

Fault	Reason	Recommended Solution
Visually the system is not aligned straight.	<ol style="list-style-type: none"> 1. Level is not working. 2. Floor is not leveled. 3. Level is damaged. 4. Post was knocked with impact. 	<ol style="list-style-type: none"> 1) Set up the post following Post Assembly instructions. Check visually and with master level to ensure the post is aligned straight. <p>Note: Never unlock the post with the track connected</p> <ol style="list-style-type: none"> 2) Check the floor with master level for flatness. 3) Visually check the level is fine. 4) Dismantle the post following “Post Disassembly Instructions” and set up the Post again following “Post assembly instructions”. <p>Note: Never unlock the post with the track connected</p> <p>If problem persists, contact your local authorized dealer immediately</p>
Feet are slipping after installation.	<ol style="list-style-type: none"> 1. Feet are not cleaned. 2. Floor is not cleaned. 	<ol style="list-style-type: none"> 1) Clean the feet as per “Cleaning Rubber Feet Instructions”. 2) Ensure floor area is dry and free of debris . <p>If problem persists, contact your local authorized dealer immediately .</p>
Lever is not engaged with magnet.	<ol style="list-style-type: none"> 1. Post Assembly instructions not followed . 2. Clutch bearing function fails. 3. Lever not cleaned. 	<ol style="list-style-type: none"> 1) Press in the Ratchet and hold it. Grab the lever and push up to the magnet label. 2) Contact local authorized dealer immediately. 3) Ensure lever is cleaned and free of grease or dirt. <p>If problem persists, contact your local authorized dealer immediately .</p>
Pressure gauge is not in safe zone.	<ol style="list-style-type: none"> 1. Post assembly instructions not followed . 2. Barrel nut is loose or not secured tightly. 3. Top plate Spring broken or bend. 	<ol style="list-style-type: none"> 1) Set up the post following post assembly Instructions. 2) Tight the barrel nut with Flat Screw Driver. 3) Contact local authorized dealer immediately.
The Adjustable Track does not extend smoothly or doesn’t extend up to required limit.	<ol style="list-style-type: none"> 1. Physical damage to track. 2. Track slots are not cleaned. 	<ol style="list-style-type: none"> 1) Check for physical damage to track. If so, contact local authorized dealer immediately. 2) Clean the track slots with cloth and wipe out the dirt or debris. Again try extending the tracks. <p>If problem persists, contact your local authorized dealer immediately .</p>
Trolley does not move smoothly along the adjustable track.	<ol style="list-style-type: none"> 1. Physical damage to track or trolley wheels. 2. Track slots or trolley wheels are not cleaned. 	<ol style="list-style-type: none"> 1) visually make sure tracks and wheels are fine and are free of obstacles. 2) Ensure that tracks are cleaned with cloth and free of dirt. <p>If problem persists, contact local authorized dealer immediately.</p>

Fault	Reason	Recommended Solution
The adjustable track is not locking on the Post Pins.	<ol style="list-style-type: none"> 1. One or more track connector Bracket(s) are damaged or broken. 2. Track lock pin(s) is(are) broken or damaged. 	<p>Do not use the system. Contact your local authorized dealer immediately.</p>
Misalignment of adjustable track on the Post Pins.(for Example; track is not sitting straight on the post assembly)	<ol style="list-style-type: none"> 1. Track connector hooks are not sitting right on the post pins. 	<ol style="list-style-type: none"> 1) Check “ Mounting adjustable Track Assembly instructions” in the user’s manual. 2) Check visually to ensure track connector hooks are sitting at the same height. <p>If problem persists, contact local authorized dealer immediately.</p>
Post cannot retract.	<ol style="list-style-type: none"> 1. Ratchet is not held during disassembly. 2. Lever arm is not engaged with magnet. 	<ol style="list-style-type: none"> 1) Follow “ Post Disassembly” instructions to dismantle the post. 2) Follow “ Post Disassembly” instructions to dismantle the post.
Safety Lock Not working.	<ol style="list-style-type: none"> 1. Red button is not pressed in enough. 2. Physical damage to safety lock cover. 3. Lock latch Spring breaks 	<ol style="list-style-type: none"> 1) Press in the Red button all the way so that safety lock can be engaged. 2) Contact local authorized dealer immediately. 3) Contact local authorized dealer immediately.
Difficult to insert top and bottom foot into Post assembly.	<ol style="list-style-type: none"> 1. Top post spacer damaged 2. Bottom post plug damaged. 3. Bottom plate foot post damaged or bend. 4. Top plate foot post damaged or bend. 	<p>Contact local authorized dealer immediately to continue the proper functioning of Pressure Fit System.</p>
Track Connector Bracket are loose.	<ol style="list-style-type: none"> 1. Rivets are broken or loose. 	<p>Do not use the system. Contact your local authorized dealer immediately.</p>

General Inspection and Maintenance



Failure to follow inspection and maintenance instructions below as instructed may result in serious injury or death.

Periodic general inspection and maintenance should be performed by a person who is properly qualified and trained with the use and care of The Pressure Fit System.

Any defects and damage to the Pressure Fit System that have lead to corrective actions should be noted and dated by the inspector. The defects and corrective actions report should be submitted in written form to the dealer.

Upon Receipt of The pressure Fit system:

- Ensure all the received components are according to the component list.
- Ensure the user manual is present other wise do not install the pressure fit system.
- Ensure all the components are in working condition and not damaged.
- Ensure service record history forms are included in the package to record any completed service and repairs.
- Complete the **Purchase and Service Information** as soon as this equipment is installed.

Periodic maintenance:

- Ensure all the components of Pressure Fit System are in working condition. If damaged, please contact the dealer for replacement before use.
- Inspect all the joints and components for wear and fatigue. If the parts are damaged, then contact dealer for replacement of parts.
- Clean the rubber feet according to “Cleaning Rubber Feet Instructions”.
- Check rubber feet for damages. If damage is noticed , please contact dealer for replacement.
- Check the Track and trolley for dirt and debris. It should be cleaned with cloth during every use.
- Ensure the labels are legible and in good condition. If not contact dealer for replacement.
- Record the service record history form for any completed service and repairs.
- Ensure that the service record is signed and dated each time it is used.



Follow the general inspection and maintenance instructions for portable lift as mentioned in it's manual.

FAILURE TO COMPLY WITH THIS MAY RESULT IN INJURY TO THE INDIVIDUAL BEING LIFTED AND/OR THE CAREGIVER, OR DAMAGE TO THE LIFT AND/OR THE PRESSURE FIT SYSTEM.

General Inspection and Maintenance

A) Each Use - To be completed by User

Prior to each use, the Pressure Fit System and associated lift, accessories and sling (s), must be visually inspected. Refer to the lift, accessory and sling user guides for specific details regarding their inspection.

Should any of the these items below fail the inspection do not use the Pressure Fit System
Contact your local authorised dealer for service.

Visually check for the following:

- The pressure fit system parts should not be loose, broken or bend.
- Ensure ceiling area is rigid and without cracks, dust, grease and any slippery substance.
- The Bases are on a stable, level surface and the Side Support Assemblies are secure.
- The Trolley moves easily along the track.
- The Top and Bottom Foot must be cleaned with wet cloth before installation in order to remove dirt on rubber moulds. “ see cleaning rubber feet”
- The Adjustment Track is placed in the correct location for transferring.
- The portable lift has been inspected as outlined in it’s owners manual.
- The sling (s) has been inspected as outlined in it’s owners manual.

B) Cleaning Rubber Feet Instructions:

Prior to each use, the Top and Bottom rubber feet need to cleaned with wet cloth soaked with water.



Step 1: Take the Bottom rubber foot and wipe off the dirt with a wet cloth as shown in picture.



Step 2: Take the Top rubber foot and wipe off the dirt with wet cloth as shown in the picture.

Note:

After cleaning, Make sure the rubber feet are clean and dry with no residue of dirt or dust left on them.
Also, ensure Floor area is cleaned and free of dirt & debris.

Service Record History - Initial Information

- Complete the following section- **Purchase and Service Information** as soon as this equipment is installed.
- Use the service record history to record any completed service and repairs.
- Ensure that the service record is signed and dated each time it is used.
- Be sure to have this piece of equipment serviced on a regular basis as described in the General Inspection and Maintenance Section

PURCHASE INFORMATION:

Product Name: **Pressure Fit System** **Serial#:** _____

Date of Purchase: _____ **Date Installed:** _____

Purchased From: _____

Address: _____

City: _____ **Post Code:** _____

Telephone No: _____

Comments:

SERVICE INFORMATION:

Contact the following company for service:

Company: _____

Address: _____

City: _____ **Post Code:** _____

Telephone No: _____

Comments:

Service Record History

Complete this section after each service, repair inspection and/or maintenance. Photocopy additional pages as required.

Date: _____		Time: _____	
Service Type: <input type="checkbox"/> Periodic Inspection <input type="checkbox"/> Monthly Inspection <input type="checkbox"/> 6 Month Inspection <input type="checkbox"/> Repair <input type="checkbox"/> Yearly Inspection <input type="checkbox"/> Other: _____			
Completed By: _____		_____	
Printed Name		Signature	
Company: _____			
Remarks & Action Taken:			

Date: _____		Time: _____	
Service Type: <input type="checkbox"/> Periodic Inspection <input type="checkbox"/> Monthly Inspection <input type="checkbox"/> 6 Month Inspection <input type="checkbox"/> Repair <input type="checkbox"/> Yearly Inspection <input type="checkbox"/> Other: _____			
Completed By: _____		_____	
Printed Name		Signature	
Company: _____			
Remarks & Action Taken:			

Date: _____		Time: _____	
Service Type: <input type="checkbox"/> Periodic Inspection <input type="checkbox"/> Monthly Inspection <input type="checkbox"/> 6 Month Inspection <input type="checkbox"/> Repair <input type="checkbox"/> Yearly Inspection <input type="checkbox"/> Other: _____			
Completed By: _____		_____	
Printed Name		Signature	
Company: _____			
Remarks & Action Taken:			

Date: _____		Time: _____	
Service Type: <input type="checkbox"/> Periodic Inspection <input type="checkbox"/> Monthly Inspection <input type="checkbox"/> 6 Month Inspection <input type="checkbox"/> Repair <input type="checkbox"/> Yearly Inspection <input type="checkbox"/> Other: _____			
Completed By: _____		_____	
Printed Name		Signature	
Company: _____			
Remarks & Action Taken:			

Date: _____		Time: _____	
Service Type: <input type="checkbox"/> Periodic Inspection <input type="checkbox"/> Monthly Inspection <input type="checkbox"/> 6 Month Inspection <input type="checkbox"/> Repair <input type="checkbox"/> Yearly Inspection <input type="checkbox"/> Other: _____			
Completed By: _____		_____	
Printed Name		Signature	
Company: _____			
Remarks & Action Taken:			

Date: _____		Time: _____	
Service Type: <input type="checkbox"/> Periodic Inspection <input type="checkbox"/> Monthly Inspection <input type="checkbox"/> 6 Month Inspection <input type="checkbox"/> Repair <input type="checkbox"/> Yearly Inspection <input type="checkbox"/> Other: _____			
Completed By: _____		_____	
Printed Name		Signature	
Company: _____			
Remarks & Action Taken:			

Service Record History

Complete this section after each service, repair inspection and/or maintenance. Photocopy additional pages as required.

Date: _____		Time: _____	
Service Type: <input type="checkbox"/> Periodic Inspection <input type="checkbox"/> Monthly Inspection <input type="checkbox"/> 6 Month Inspection <input type="checkbox"/> Repair <input type="checkbox"/> Yearly Inspection <input type="checkbox"/> Other: _____			
Completed By: _____		_____	
Printed Name		Signature	
Company: _____			
Remarks & Action Taken:			

Date: _____		Time: _____	
Service Type: <input type="checkbox"/> Periodic Inspection <input type="checkbox"/> Monthly Inspection <input type="checkbox"/> 6 Month Inspection <input type="checkbox"/> Repair <input type="checkbox"/> Yearly Inspection <input type="checkbox"/> Other: _____			
Completed By: _____		_____	
Printed Name		Signature	
Company: _____			
Remarks & Action Taken:			

Date: _____		Time: _____	
Service Type: <input type="checkbox"/> Periodic Inspection <input type="checkbox"/> Monthly Inspection <input type="checkbox"/> 6 Month Inspection <input type="checkbox"/> Repair <input type="checkbox"/> Yearly Inspection <input type="checkbox"/> Other: _____			
Completed By: _____		_____	
Printed Name		Signature	
Company: _____			
Remarks & Action Taken:			

Date: _____		Time: _____	
Service Type: <input type="checkbox"/> Periodic Inspection <input type="checkbox"/> Monthly Inspection <input type="checkbox"/> 6 Month Inspection <input type="checkbox"/> Repair <input type="checkbox"/> Yearly Inspection <input type="checkbox"/> Other: _____			
Completed By: _____		_____	
Printed Name		Signature	
Company: _____			
Remarks & Action Taken:			

Date: _____		Time: _____	
Service Type: <input type="checkbox"/> Periodic Inspection <input type="checkbox"/> Monthly Inspection <input type="checkbox"/> 6 Month Inspection <input type="checkbox"/> Repair <input type="checkbox"/> Yearly Inspection <input type="checkbox"/> Other: _____			
Completed By: _____		_____	
Printed Name		Signature	
Company: _____			
Remarks & Action Taken:			

Date: _____		Time: _____	
Service Type: <input type="checkbox"/> Periodic Inspection <input type="checkbox"/> Monthly Inspection <input type="checkbox"/> 6 Month Inspection <input type="checkbox"/> Repair <input type="checkbox"/> Yearly Inspection <input type="checkbox"/> Other: _____			
Completed By: _____		_____	
Printed Name		Signature	
Company: _____			
Remarks & Action Taken:			

Service Record History

Complete this section after each service, repair inspection and/or maintenance. Photocopy additional pages as required.

Date: _____		Time: _____	
Service Type: <input type="checkbox"/> Periodic Inspection <input type="checkbox"/> Monthly Inspection <input type="checkbox"/> 6 Month Inspection <input type="checkbox"/> Repair <input type="checkbox"/> Yearly Inspection <input type="checkbox"/> Other: _____			
Completed By: _____		_____	
Printed Name		Signature	
Company: _____			
Remarks & Action Taken:			

Date: _____		Time: _____	
Service Type: <input type="checkbox"/> Periodic Inspection <input type="checkbox"/> Monthly Inspection <input type="checkbox"/> 6 Month Inspection <input type="checkbox"/> Repair <input type="checkbox"/> Yearly Inspection <input type="checkbox"/> Other: _____			
Completed By: _____		_____	
Printed Name		Signature	
Company: _____			
Remarks & Action Taken:			

Date: _____		Time: _____	
Service Type: <input type="checkbox"/> Periodic Inspection <input type="checkbox"/> Monthly Inspection <input type="checkbox"/> 6 Month Inspection <input type="checkbox"/> Repair <input type="checkbox"/> Yearly Inspection <input type="checkbox"/> Other: _____			
Completed By: _____		_____	
Printed Name		Signature	
Company: _____			
Remarks & Action Taken:			

Date: _____		Time: _____	
Service Type: <input type="checkbox"/> Periodic Inspection <input type="checkbox"/> Monthly Inspection <input type="checkbox"/> 6 Month Inspection <input type="checkbox"/> Repair <input type="checkbox"/> Yearly Inspection <input type="checkbox"/> Other: _____			
Completed By: _____		_____	
Printed Name		Signature	
Company: _____			
Remarks & Action Taken:			

Date: _____		Time: _____	
Service Type: <input type="checkbox"/> Periodic Inspection <input type="checkbox"/> Monthly Inspection <input type="checkbox"/> 6 Month Inspection <input type="checkbox"/> Repair <input type="checkbox"/> Yearly Inspection <input type="checkbox"/> Other: _____			
Completed By: _____		_____	
Printed Name		Signature	
Company: _____			
Remarks & Action Taken:			

Date: _____		Time: _____	
Service Type: <input type="checkbox"/> Periodic Inspection <input type="checkbox"/> Monthly Inspection <input type="checkbox"/> 6 Month Inspection <input type="checkbox"/> Repair <input type="checkbox"/> Yearly Inspection <input type="checkbox"/> Other: _____			
Completed By: _____		_____	
Printed Name		Signature	
Company: _____			
Remarks & Action Taken:			

Warranty

This Warranty does not affect or in any way limit your Statutory Rights

- 1) Subject to the exclusions set out in Clause 2, the conditions set out in Clause 3 and the limitations set out in Clause 4, Xcpectg. "Ipe" as sole licensed representative of Corven Healthcare Inc., guarantees all equipment supplied as new against failure within the period of 1 year from date of purchase by virtue of defects in material or workmanship.
- 2) This guarantee does not apply to failure attributable to normal wear and tear, damage by natural forces, user neglect or misuse or to deliberate destruction, or to batteries more than 90 days after original purchase.
- 3) This guarantee shall be void if the equipment is not serviced by Xcpectg. "Ipe" or its authorised service agents in accordance with the manufacturer's recommendations or if any unauthorised person carries out works on the equipment.
- 4) The liability of Xcpectg. "Ipe" under the terms of this guarantee shall be limited to the replacement of defective parts and in no event shall Xcpectg. "Ipe" incur liability for any consequential or unforeseeable losses.

If you have any questions about the manufacture or operation
of this equipment, please contact"

.....Xcpectg. "Ipe", or your local authorised dealer.

VANCARE[®]
We move body and mind

Manufactured for:
Vancare, Inc.
1515 First Street
Aurora, NE 68818

Telephone: (402) 694-4525 Fax: (402) 694-3994

Toll Free: 1-800-694-4525

This document conforms to EN ISO 10535 requirements

VANCARE Ceiling lift Skills Observation Assessment

Staff Member Observed _____

Date _____

PROCEDURE - DID THE EMPLOYEE:

- Have the required number of staff members present?
- Select the correct size sling?
- Inspect the sling and lift for damage and proper operation?
- If **DAMAGED**, did the employee get another lift/sling and notify charge nurse?
- Correctly position the sling so that the bottom center of the sling is at the tailbone?
- Perform environment assessment and move objects that would impede operation of lift?
- Move the lift into position with the hanger bar in the "H" position in front of the resident?
- Lower the lift using the Pendant Switch?
- Connect the sling loops to the hanger bar hooks? Use the same loops on each side?
Double check the sling attachment to the lift?
- Lift the resident only as high as necessary?
- Moving the lifter with a patient in the sling?
- Lower the lift until the resident is sitting on the chair or lying on the bed?
- Remove the sling loops from the hanger bar hooks, and prevent the hanger bars from coming in contact with the patient?
- Back the lift away from the resident and remove the sling?
- Make certain the resident is safe and comfortable before leaving?

KNOWLEDGE – CAN THE EMPLOYEE:

- Identify lifting capabilities (maximum weight)?
- Identify location and use of Emergency Stop Switch?
- Identify location and use of Emergency Lowering?
- Identify location and use of Auxiliary Up/Down Switch?
- Identify Low Battery Indicator light and/or LCD Battery Display?
- Demonstrate how and when to recharge batteries?
- Use the Scale attachment properly?
- Identify sling parts: head support, shoulder loops, leg supports, leg loops, stabilizing handles?
- Demonstrate ability to adjust angle of recline to maintain hip precautions?
- Demonstrate transfer of patient, using Vancare ceiling lift, from bed to chair, chair to bed, and floor to bed?
- Demonstrate proper understanding of how to clean the sling and lift?

Refer to Operator's Manual for more detailed description of transfer technique.

Pass

Fail

Observations _____

Observer's Name _____

Observer's Signature _____