

Max: 205kg/450 lbs

The VanTurn 450 is used indoors for shorter transfers between wheelchair and bed, wheelchair and toilet/portable toilet/wheelchair or chair/arm chair. The VanTurn 450 can also be used to aid repositioning farther back in the chair. The VanTurn 450 is designed for easy maneuvering and use in confined spaces. It is easy to assemble and disassemble in just two sections for easier transport and storage.

Vancare has a series of different models of transfer assistive devices. The choice of assistive devices depends on the transfer situation and the patient's functional capability and needs.

Functional inspection

Visual inspection

Check the condition and function of the product regularly. Check to ensure that material is free from damage. If there are signs of wear, the product must be inspected and serviced.

Always read the manual

Always read the manuals for all assistive devices used during a transfer.

Keep the manual where it is accessible to users of the product.

Do not leave the patient unattended during a transfer situation.

The product should be inspected yearly, and otherwise as required, by a qualified technician. Service must be performed by a qualified technician.

Assembly

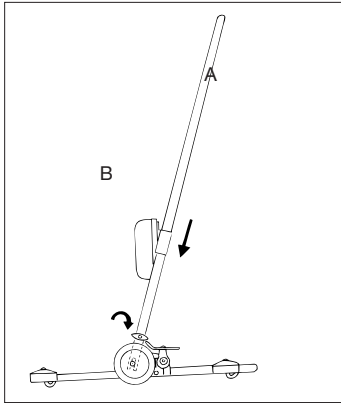

A. Push the rising ladder/tube down into the mounting fixtures on the chassis, so that the height-adjustment buttons are facing towards the caregiver.

B. Insert the fixture knobs and tighten. Check to ensure that the fixture knobs are securely tightened before using the VanTurn 450.

Special requirements and conditions

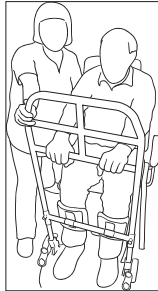

- VanTurn 450 is intended for shorter transfers.
- VanTurn 450 can only be used on a flat surface.
- The caregiver must always apply counter pressure in a safe way when the patient is standing up, sitting down and during the actual

NOTE! Always perform a risk assessment before using the VanTurn 450.



To transfer with the VanTurn 450, the patient must be able to:

- support weight while standing
- stand up and maintain balance (with support)
- grasp handles
- understand instructions

Transport

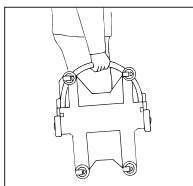

The chassis and raising ladder can be carried separately. Carry the chassis by holding the tube on the front end of the product.

Transport, e.g., by car, and storage are easy, since the VanTurn 450 can be disassembled in two pieces.

Chassis and placement of feet

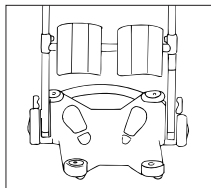

The feet are placed one on either side, see foot markings on base plate.

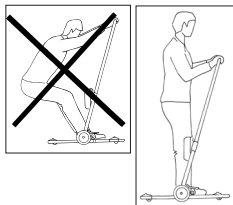

The patient's weight must be centered on the VanTurn 450's support surface (all weight between the wheels) i.e. the patient must be in a standing position. The patient's weight must not be outside of the support surface.

Brakes

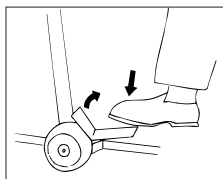

There is a brake for each wheel. With your foot, press down on the red marking on the brake plate. Press all the way down.

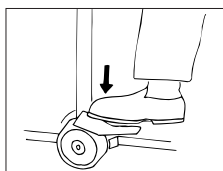

To release the brake, press on the brake plate so that it resumes its original position (green marking); ensure that the wheels roll freely.

Lower-leg support

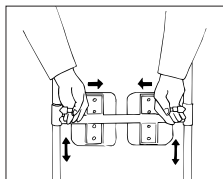

Adjust the lower-leg support so that the upper edge of the plate is about 3 cm/two fingers below the lower edge of the kneecaps. Pull the two pins to loosen. Adjust to the appropriate height. Ensure that the pins lock securely into place. The lower-leg support can also be adjusted laterally.

Testing standing function



The VanTurn 450 is ideal for testing a patient's standing function in cases where there is uncertainty as to whether the patient is able to rise from a seated to a standing position.

Training standing function



The VanTurn 450 can be used to train the patient's standing, sitting and sit-to-stand function. To measure improvement, use a stopwatch or clock with a second hand to time the patient.

Farther back in the chair

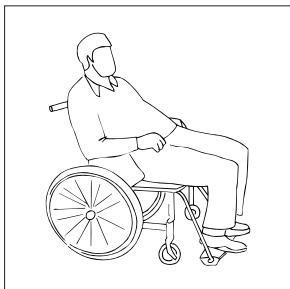

If the patient slides forward in the wheelchair, the VanTurn 450 can be used to help the patient to slide farther back in the chair.

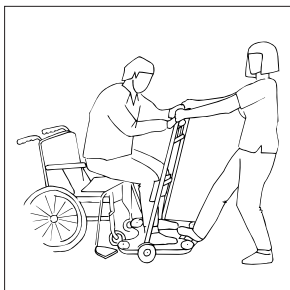

Remove/raise the wheelchair foot plates, and then run the VanTurn 450 in towards the wheelchair. The patient places his/her feet on the foot plate, grasps the raising ladder, leans forward, and then lifts from the seat. The caregiver provides counter pressure. Slide the patient farther back in the chair when he/she has lifted slightly from the seat.

Transfers



Bed to wheelchair

Place the wheelchair at some distance from the bed to allow enough working space. Lock the wheelchair wheels. Place the patient's feet on the base plate. The patient grasps the raising ladder, leans forward, and then raises himself/herself.



Pull the VanTurn 450 back somewhat, and steer in towards the wheelchair.



Position the VanTurn 450 close enough to enable good placement in the wheelchair. The caregiver applies counter pressure before the patient sits down.

Using the VanTurn Belt together with the VanTurn 450

See manual for the VanTurn Belt

The Vanturn belt is used for raising from a seated to a standing position, and for support in the standing position in combination with the use for the VanTurn transfer platform. The Vanturn belt has a more rigid lower section for easy application and an elastic upper section for a better and more comfortable fit. The Vanturn belt has several gripping alternatives and a locking strap for extra support and safety in connection with the use of the VanTurn 450 platform.

Two caregivers with the VanTurn Belt

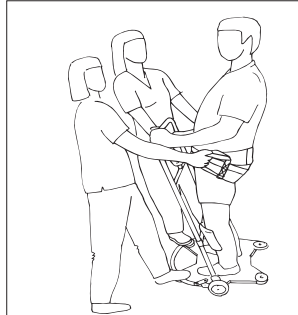
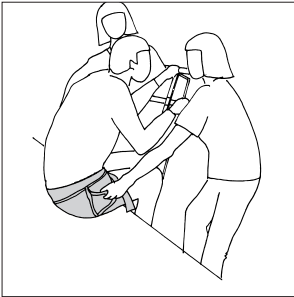

Brake the wheels on the VanTurn 450. The patient then leans forward and grasps the handles on the VanTurn 450. The caregivers then grasp the handles on the Vanturn belt.

The Vanturn belt allows different gripping alternatives, and helps and encourages the patient to lean forward. One caregiver helps the patient to lean forward and provides support during raising.

One caregiver with the VanTurn Belt

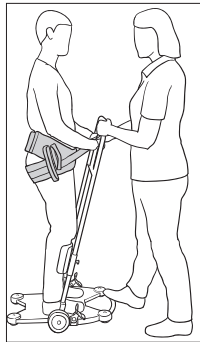
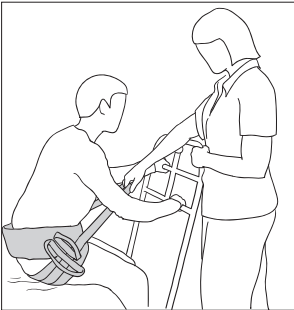

Fasten the clasp without tensioning the strap. A click is heard when the clasp is secured.

Brake the wheels on the VanTurn 450.

The caregiver encourages the patient to lean forward while providing support during raising by grasping either a handle or the strap.

The patient leans forward and grasps the handles on the VanTurn 450.

When it is necessary to attach the Vanturn Belt to the VanTurn 450

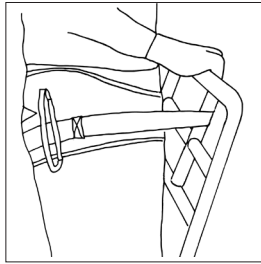
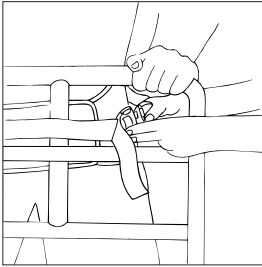

VanTurn 450:

Do not secure the clasp on the Vanturn belt before rising. When the patient is in a standing position facing the VanTurn 450, the strap can be placed around one of the vertical handles.

Secure the clasp on the VanTurn 450. A click is heard when the clasp is secured.

Now transfer the patient with the VanTurn 450. Plan carefully to ensure that the transfer is as short as possible.

Sitting down

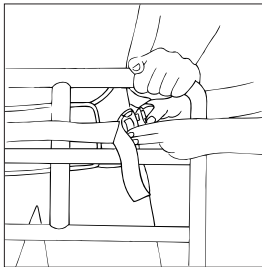

Brake the wheels on the VanTurn 450.

Ensure that the patient is standing in a secure position facing the VanTurn 450, so that the locking strap is loosened.

Undo the clasp and remove the strap from the VanTurn 450.

Fold it under the edge of the belt, so that it does not catch on anything.

Help the patient into a seated position with the help of the Vanturn belt.



To toilet/shower chair

For transfers to the toilet, space is allowed for the caregiver to assist the patient with the pants. The back also has a small recess that allows the patient to get close to the toilet and achieve a good seated position.

Technical specifications

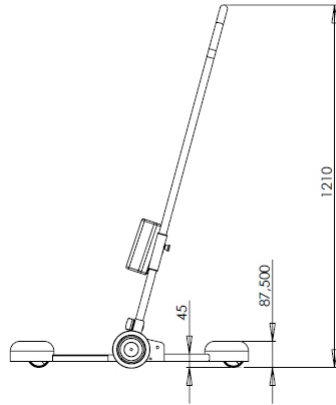
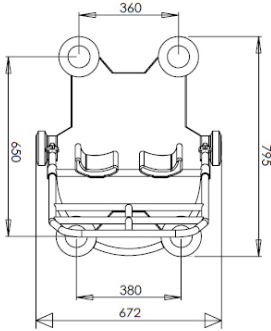

SWL, Max weight: 205 kg/450 lbs (static load)

Total weight: 26 kg/57 lbs

Patented

Care of the product

- Use a soft cloth and mild cleaning agent such as dishwashing liquid or car shampoo to clean the VanTurn 450. Do NOT use abrasive cloths or brushes to clean the base plate.
- Do not use solvents.
- To disinfect, use 70% alcohol.

Accessories

VanTurn Belt Support Straps

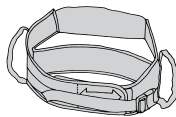

VanTurn Belt



SupportStraps

Manufactured for:

Vancare, Inc.
1515 First St
Aurora, NE 68818

1 (800) 694-4525
Fax: 402-694-3994
www.vancare.com
E-mail: info@vancare.com

VANCARE[®]
We move body and mind

VAN-TURN Skills Observation Assessment

Staff Member Observed _____

Date _____

PROCEDURE - DID THE EMPLOYEE:

- Determine if the Van-Turn is appropriate for the resident?**
Physical and cognitive guidelines:
 - Patient able to weightbear to actively participate in standing position
 - Patient is aware of surroundings and able to follow directions
 - Patient is not combative or agitated
- Have the required number of staff members present? (2)**
- Select the correct size belt?**
- Inspect the belt and Van-Turn and proper operation?**
- Perform environment assessment** and move objects that would impede operation of the Van-Turn? (floor cleared of wiring/cords, clothing, avoidance of elevated door sills, sloped surfaces)
- Correctly position the belt** around the lower abdomen and secure with the Velcro strap?
- Adjust the Van-Turn Shin Pads** up/down to be just below the knee(s), wider/narrower, and pivoting to support a leg that should not be involved in the transfer?
- Move the lift into position** in front of the resident, feet in the proper place?
- Properly using the wheel brakes** before lifting.
- Tell the resident what you are doing.**
- Utilize proper 2-person lift assist of the resident** using the two padded handles on the belt, followed by securing the safety strap around the center post and buckling to the belt, and adjusting the tension of the safety strap to maintain the desired posture of the resident?
- Release the wheel brakes** while moving the Van-Turn?
- Move to the next seated position**, reapplying the wheel brakes and telling the resident what is going to happen?
- Release the safety strap buckle** while using the two padded handles of the belt to maintain stability of the resident?
- Lower the resident** to the desired seated position while wheel brakes are engaged?
- Release the wheel brakes** to remove the Van-Turn, assisting the resident's feet off the foot plate?
- Remove the Van-Turn belt**, *thanking the resident for his/her help and cooperation?*
- Examine the belt** to determine if it is clean and ready for next use?
- Make certain the resident is safe and comfortable** before leaving?

Refer to Operator's Manual for more detailed description of transfer technique.

Pass

Fail

Observations _____

Observer's Name _____

Observer's Signature _____